

VISUAL FEEDBACK OCULOMOTOR TRAINING SYSTEM *for* YOUNG CHILDREN

■ Daniella Rutner, O.D., M.S.
■ Kenneth J. Ciuffreda, O.D., Ph.D.

Abstract

The purpose of this study was to determine if external oculomotor visual feedback can be conceptualized and used by young children (5-10 years of age) to improve their eye movement control. Horizontal eye movements of the right eye were monitored objectively in five visually-normal children and one nystagmat under binocular viewing conditions; in addition, two visually-normal adults and one adult nystagmat were tested as controls. All subjects were instructed to reduce their horizontal fixational eye movements within preset but variable criterion ranges (± 1.75 and $\pm 3.5^\circ$) while attempting to fixate accurately on the video image of a storyteller ($7^\circ H \times 11^\circ V$) displayed at the bottom of a television screen placed at near (33cm) along the midline. If successful, the video portion of the image remained visible; if not, the video portion was extinguished, and only the audio portion remained until accurate fixation was re-established. A similar paradigm was followed for saccadic eye movements. All children and adult subjects understood the instructions and were successful in controlling their eye movements within the specified criterion level 90% of the time by the end of one training session. Moreover, the young child with nystagmus was able to reduce his nystagmus in both frequency and amplitude by the end of the first session, and in the subsequent three sessions. Our findings indicate that

oculomotor-based visual feedback training appears to be a viable alternative to oculomotor auditory feedback and other more conceptually complicated procedures in young children, as well as in other diagnostic groups, to improve oculomotor control.

Key Words

auditory feedback, children's vision, eye movements, nystagmus, vision development, vision training, visual feedback

Introduction

There are a growing number of complementary and alternative preventive, diagnostic and therapeutic modalities currently being used in clinical medicine in addition to the conventional pharmacological and surgical approaches. Among these therapeutic modalities is the use of external feedback (i.e., "biofeedback").¹ This is a technique that enables conscious mental control and manipulation of a previously unconscious bodily process by making this involuntary process or its correlate perceptible to the senses.^{1,2} Some external signal, such as a tone or visual target, is varied in a systematic manner and correlated with changes in the response properties of the process (or system) one is attempting to control. This enables an individual to learn to increase, decrease, or modify an otherwise involuntary physiological function.

Although considered a "soft science" when introduced in the late 1950's and 1960's, external feedback is now more widely recognized as a legitimate proce-

dures for treating a wide spectrum of medical problems, including spinal chord injuries, migraines, seizures, cerebral palsy, and strokes,¹ as well as a number of ophthalmic conditions.² External feedback uses modern technological instrumentation that enables the individual to be cognizant of physiological functions of which he is normally unaware and to alter these physiological functions so that they can be controlled and operated at more effective levels. The patient achieves this via a trial-and-error learning process that provides instantaneous sensory information (i.e., visual, audio, or tactile) regarding his/her physiological state, such as muscle tension, brain wave activity, blood pressure, skin surface response and heart rate.³ Such a multi-sensory feedback approach has been used by us for many years in our oculomotor therapeutic handling of adult nystagmus (Figure 1 and Table 1).^{4,5} This involves basic practice, shaping, conditioning, and reinforcing principles of psychology learned during the feedback sessions.^{6,7}

Our initial impression that young children (i.e., ages 5-10 years) may not be able to comprehend, and hence respond properly to external oculomotor auditory feedback and the related and necessary auditory-oculomotor transform, was confirmed by our earlier attempts and preliminary investigations. Thus, the purpose of the present study was to use a more direct external oculomotor visual feedback approach (i.e., visual-oculomotor transform) in young children to circumvent this problem.

Methods

Subjects

Four groups of subjects were tested. These included:

1. Five visually-normal children. Classification of visually-normal was based primarily on careful case history from the parents. Furthermore, four out of the five children did not wear corrective lenses, were symptom free, and did not have obvious eye disorders such as strabismus or nystagmus as evidenced in the objective eye movement records and by gross visual observation. They were 5, 6, 7½, 9, and 9 years of age. Two of the subjects each received two sessions, while three of the subjects received only one session.
2. One child with nystagmus was 7 years old. The diagnosis of periodic alternating (jerk) nystagmus (PAN)⁸ was established by the child's ophthalmologist. Due to the predicted variation in nystagmus direction and intensity characteristics of PAN every 3 minutes or so, only relatively short test segments were analyzed to preclude such possible contamination of our objective findings. Snellen visual acuity was 20/30 monocularly and binocularly. He had four test sessions over a 6-week period.
3. One young adult with congenital, non-PAN, jerk nystagmus who had received several years of oculomotor auditory feedback training by us for her nystagmus. Visual acuity was 20/100 binocularly. She had one test session.
4. Two visually-normal young adults each received one test session.

Apparatus

The subject was positioned in a padded chinrest/headrest. It was also fitted with Velcro straps to minimize head movement.

Subjects wore a custom-designed and fabricated ophthalmic spectacle frame, appropriately sized, which incorporated mounted infrared sensors and emitters.⁹ These frames were fitted with Velcro straps to secure them to the patient's head to minimize sensor movement. Horizontal eye movements of the right eye were monitored during binocular viewing. System resolution was 0.25°, and linearity was at least ±8.0°. Limitation of the overall system bandwidth was due to the strip chart recorder (dc to 50Hz). Eye move-

ments were recorded using the infrared limbal reflection technique.⁹ The emitters radiated very low wattage infrared light that illuminated the entire exposed region of the eye, with the sensors aimed at the nasal and temporal horizontal limbal regions. The small incremental reflectivity differences related to changes in horizontal eye position provided the initial differential signal, which was then converted to a current that was then converted to a change in voltage. This eye movement-related voltage signal was input to three devices: a three-channel strip chart recorder, the video visual feedback stimulus system with the deadzone video control circuit for the television monitor, and optionally into a custom oculomotor auditory feedback system for dual feedback (i.e., visual and auditory) presentation (Figure 2).

Functionally, the deadzone, or deadband video control circuit, was used to preset the total range of allowable horizontal eye movement (Figure 3). The experimenter first preset the criterion level. The total lateral angular range could be adjusted from 0.5° to 10° at the 33cm test distance. It

was initially set to ±3.5°, and later to ±1.75° as the subject exhibited improved fixational control. This on/off deadzone control switch received direct input from the eye movement system. When the horizontal eye movement-related voltages exceeded the preset range limit, the video on the television monitor was extinguished, but the audio portion of the storytelling remained on for story continuity (See later.). When the horizontal eye movement-related voltages were subsequently reduced to lie within the present range, the video component was restored.

Stimulus

The video stimulus was presented on a 13-inch Panasonic television/VCR com-

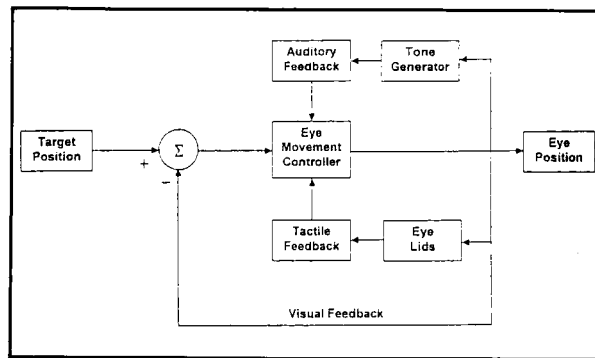

Figure 1. Block diagram of a multi-sensory oculomotor feedback model showing visual, auditory, and tactile loops.

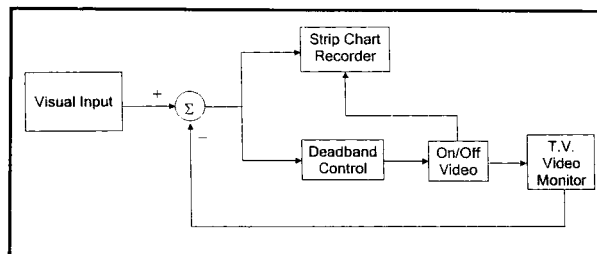

Figure 2. Block diagram of the visual feedback eye movement training system developed by the authors.

Table 1 Nystagmus Multi-Sensory Feedback Clinical Therapy Protocol

- Auditory feedback (phase 1 and 2)
 - fixation
 - version (saccades and pursuit)
 - reading (simulated)
 - vergence
- Visual feedback (phase 2)
 - version and vergence eye movement training
 - sustained afterimages
 - very low contrast target discrimination
 - fine line separation discrimination
- Tactile feedback (phase 2)
 - digital assessment
 - rigid contact lenses

bination placed 33cm from the subject along the midline. The videotape presented the face and upper body of a storyteller (the first author) in the extreme center-lower border of the screen against a white backdrop, with no other visual stimuli presented, in order to reduce potential distractions. At 33cm, the image of the storyteller's face and upper body subtended a visual angle of 7° horizontally, with this being approximately 3.5° to the right or left of both the storyteller's and the subject's facial midline; it subtended 11° vertically. Three short stories were carefully selected with the aid of librarians and bookstore attendants. These included: *Where The Wild Things Are* by

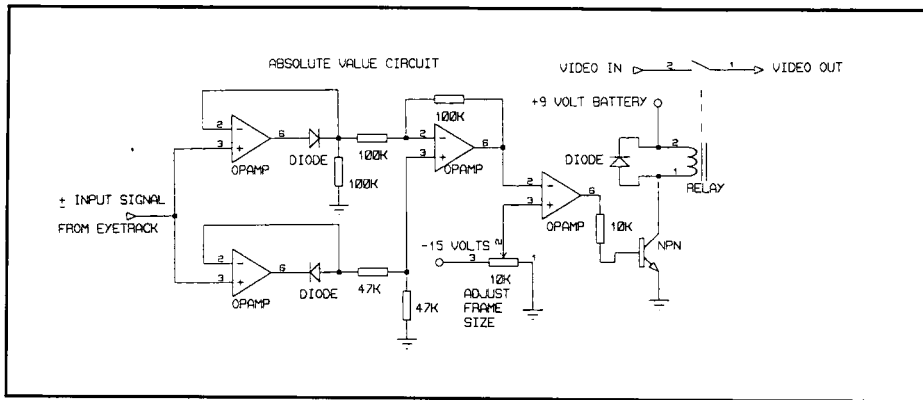

Figure 3. Schematic diagram showing the deadzone video control circuit of the system. From left to right: two directionally-sensitive voltage followers, a differential amplifier, a threshold level adjust, a voltage comparator, and a signal conditioner.

Maurice Sendak, *Quiet Wyatt* by Bill Maynard, and *The Giving Tree* by Shel Silverstein.

Calibration and Procedure

A transparent horizontal calibration target measuring 41mm horizontally and 10mm vertically was attached to the monitor. At 33cm, it subtended $7^\circ (\pm 3.5^\circ)$ about the center of the lower portion of the monitor total visual angle, which was equal to the horizontal extent of the storyteller's image. It was numbered from 1 through 5 and was placed directly below the image of the storyteller's face on the upper torso. The center point of the transparent strip was labeled 3 (0.0°), with two secondary points on each side equidistant from this center point labeled 1 (3.5° left), 2 (1.75° left), 4 (1.75° right), and 5 (3.5° right), respectively.

The basic protocol of the experiment was then explained to the subject. Each was told that he/she could learn to use his/her eye movements to control the television monitor and story, i.e., turn the picture on or off by moving his/her eyes appropriately. They were instructed to move their eyes only, while keeping their head and body as still as possible. The subject was then positioned within the padded chin and headrest unit.

For calibration purposes and preliminary recordings, the subject was asked to fixate on the center calibration target number 3 of the calibration strip. They were then asked to fixate on number 1, then 5, and then back to 3. At times, a more detailed calibration was performed in the following sequence 1, 2, 3, 4, 5, 4, 3, 2, 1. The purpose of this second type of calibration was to establish and verify both the horizontal perimeters of the stimulus and to as-

sure working within the linear range of the eye movement system. During the experiment, the deadband region was always centered with respect to calibration target 3.

The video image was then displayed on the television monitor. The storyteller's face was centered directly above the transparent calibration strip. The subject was reminded to look at the center of the storyteller's face (specifically the storyteller's nose, which was aligned vertically with the number 3 on the transparent calibrating strip below) to be able to see the storyteller and hear the story concurrently. The experimenter then assessed the traces on the three-channel strip chart recorder which objectively documented the subject's eye movements. In addition, the experimenter provided verbal feedback, e.g., "that's great," "keep up the good work," "try to keep the picture on the screen," etc., to the subject. The subject was then asked to position his/her eyes just beyond number 1 and then just beyond number 5, which resulted in the video portion being extinguished per the initial $\pm 3.5^\circ$ deadzone criterion. Then the subject was asked to look at number 3, which resulted in restoration of the video portion. This demonstration task was repeated a number of times and eye movements were continuously recorded. The subject was then asked to "shut the picture off with your eyes" and after few seconds to "make it come back with your eyes." Lastly, the subject was asked to maintain steady fixation on the storyteller's nose for at least 15 seconds.

The next phase of the experiment attempted to establish a more stringent criterion level for the allowable range of horizontal eye movements. The experi-

menter reduced the electronic deadzone, such that when it was exceeded, a smaller range of eye movements would now extinguish the video portion. Calibrations were repeated to establish and verify the reduced allowable horizontal perimeters ($\pm 1.75^\circ$). The subject was asked to execute saccades to the right and left of center that were just sufficiently large for the video to be extinguished. Next, the subject was requested to look at number 3, which would restore the video portion. The subject was then asked to execute saccadic eye movements that were just large enough to extinguish the video portion, followed by corrective saccadic eye movements that were just small enough to restore it. Lastly, the subject was asked to maintain steady fixation, and hence maintain the video portion on continuously for at least 15 seconds.

In addition to following the above visual feedback experimental test paradigms, one subject in each subgroup was presented with oculomotor-based external auditory feedback in conjunction with the oculomotor-based external visual feedback. They were requested to keep the tone constant while maintaining steady fixation on the storyteller's nose at all times; a steady tone reflected stable horizontal eye position.⁵

Results

Visually-Normal Adults

Figure 4 presents a recording for one of the visually-normal adults; similar results were found in the other adult. In the first third of the trace, the subject was instructed to just exceed the $\pm 3.5^\circ$ lateral calibration markers (i.e., targets 1 and 5) such that the deadband ($\pm 3.5^\circ$) was activated with concurrent extinguishing of the video aspect; a similar instruction was given with the deadband set at $\pm 1.75^\circ$ in the latter third of the record. In both cases the subject was successful in rapidly and consistently achieving the task. And, in the middle third of the recording, the subject was instructed to maintain steady fixation on the midline calibration target (#3), and again was successful with complete retention of both the video and audio aspects. These results clearly demonstrate the ease of understanding the instructions and task, and the rapid adaptive oculomotor control ability, as well as the reliability of the feedback system to track faithfully the rapid voltage changes de-

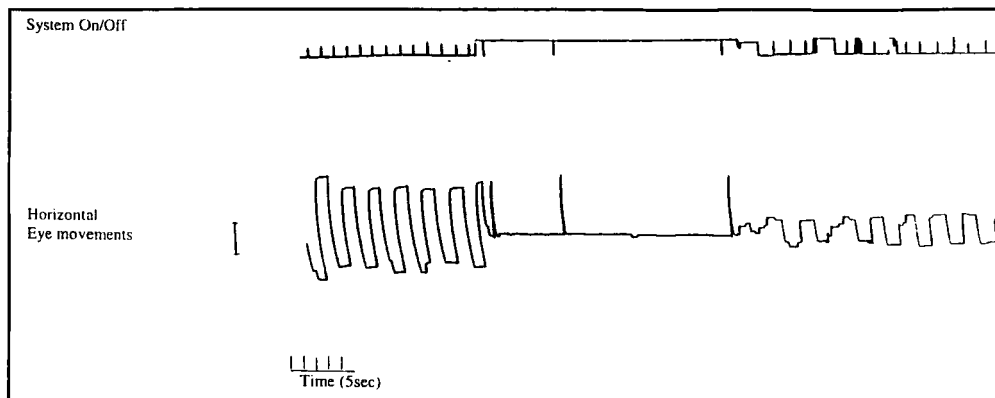

Figure 4. Eye movements and system responses in a visually-normal adult. Calibration bar on left represents 3.5°. Conventions for this and all other figures: for eye movements, up is left, and down is right; for the stimulus system, up is on, and down is off.

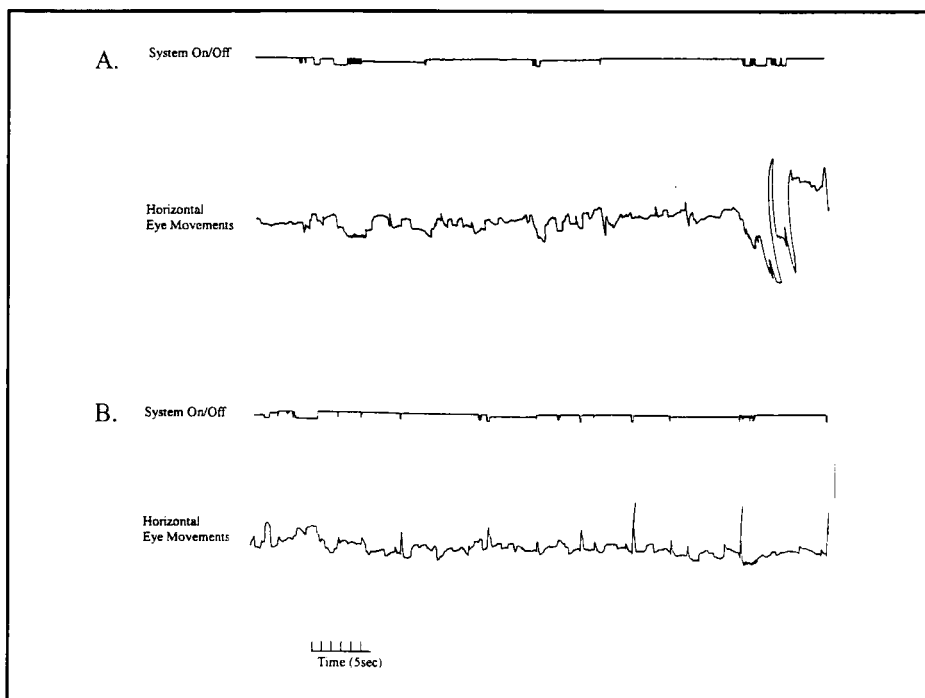

Figure 5. Eye movements and system responses in a 5-year-old, visually-normal child. Deadband $\pm 3.5^\circ$. (a) At beginning of first session; large left and right deflections at end of record represent the calibration ($\pm 3.5^\circ$) (b) At end of first session; large spike-like deflections at end of record represent blinks.

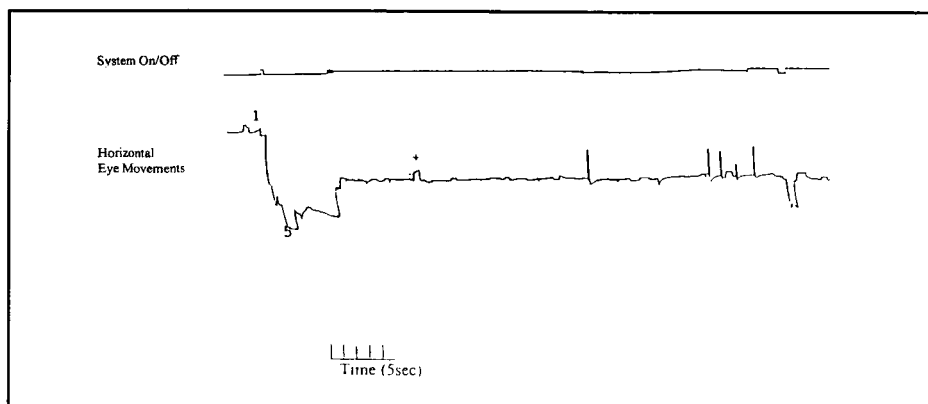

Figure 6. Eye movements and system responses in a 6-year-old, visually-normal child. Initial calibration (1, 5) ($\pm 3.5^\circ$) is followed by midline fixation with visual feedback system in operation; at the + sign, oculomotor auditory feedback was added concurrent with the visual feedback. Deadband $\pm 3.5^\circ$.

rived from the eye movement system associated with the saccadic eye movements.

Visually-Normal Children

Visually-normal children as young as 5 years of age had little difficulty in understanding and complying with the overall task. This is evidenced in Figure 5. In Figure 5a, the 5-year-old normal child is attempting to fixate on the midline target within the first few minutes of the first session with the deadzone set at $\pm 3.5^\circ$. He was successful over 90% of the time. This subject's fixation at the end of the 30-minute session is shown in Figure 5b. Again, he was successful the vast majority of the time. In both examples, single saccades, saccadic intrusions, and drift movements, probably with some undesired small and intermittent head movements, were present. Thus, this very young child could maintain both the criterion level of fixation and sufficient attention during the test period to achieve the desired oculomotor goal.

The recording of a 6-year-old child is presented in Figure 6. Following the initial $\pm 3.5^\circ$ calibration, the subject fixated the storyteller's nose for over 5 seconds successfully. Then, oculomotor auditory feedback was introduced at the + sign. With either visual feedback or combined visual and auditory feedback, the child fixated the target within the deadzone criterion level almost 100% of the time. Following the session, the subject indicated that addition of the audio information did not appear to aid in his ability to accomplish the required task. Fixation during other times in the session with only visual feedback was similar.

The older children responded similarly. However, they appeared to have slightly greater ease in extinguishing and reestablishing the visual stimulus, as well as maintaining steady fixation upon command for longer periods of time, frequently up to 3 minutes. This was attributed to age-related increased attentional ability.

Adult Nystagmat

The young adult with nystagmus, who had received several years of successful oculomotor auditory feedback in our clinic, was also able to comprehend the feedback concept and general intentions of the experiment. Furthermore, the elec-

tronic circuitry of the device could track the rapid nystagmoid movements reasonably faithfully. This is shown in Figure 7. Following the initial calibration, the subject could maintain the criterion level of fixation for the majority of the time; as the session progressed, fixational ability improved yet further.

Child Nystagmat

The 7-year-old child with congenital nystagmus (PAN) was able to comprehend the concept and visual control aspect well in the first session (Figure 8). In Figure 8a, following the initial $\pm 3.5^\circ$ calibration, the child was able to maintain his nystagmus amplitude within the criterion level quite well. Near the end of the session, the deadzone level was reduced to $\pm 1.75^\circ$, thereby making the criterion fixation more difficult (Figure 8b). However, within 3 minutes, marked improvement was achieved (Figure 8c).

At the second session, similar results were found for both the standard $\pm 3.5^\circ$ (Figure 9a) and more stringent $\pm 1.75^\circ$ (Figure 9b) deadband fixational criterion levels. The same was true at the third and fourth sessions. At the fourth and last session, oculomotor auditory feedback was introduced in isolation as well as in conjunction with the oculomotor visual feedback. While the child indicated that he understood the meaning of the audio information, as well as the necessary auditory-oculomotor transform, he did not appear to use this information successfully to reduce his nystagmus further; however, the test period was only 15 minutes in duration.

Discussion

Relatively few studies have investigated the training of oculomotor control in young children.^{9,11} It is necessary to develop appropriate feedback training paradigms that will allow children with various oculomotor dysfunctions (e.g., nystagmus) to gain better control of their eye movements in order to enhance visual acuity and other sensorimotor vision functions at an early age.

Young children have considerable visual system plasticity. Thus, the use of feedback training in those with oculomotor difficulties and related sensory abnormalities may be of even greater

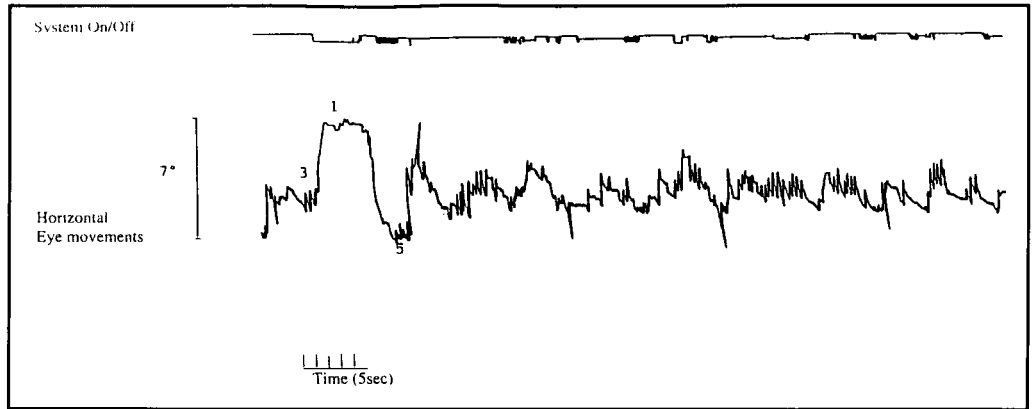

Figure 7. Eye movements and system responses in a 21-year-old adult congenital nystagmat. Calibration (3, 1, 5) ($\pm 3.5^\circ$) is followed by midline fixation. Deadband $\pm 3.5^\circ$.

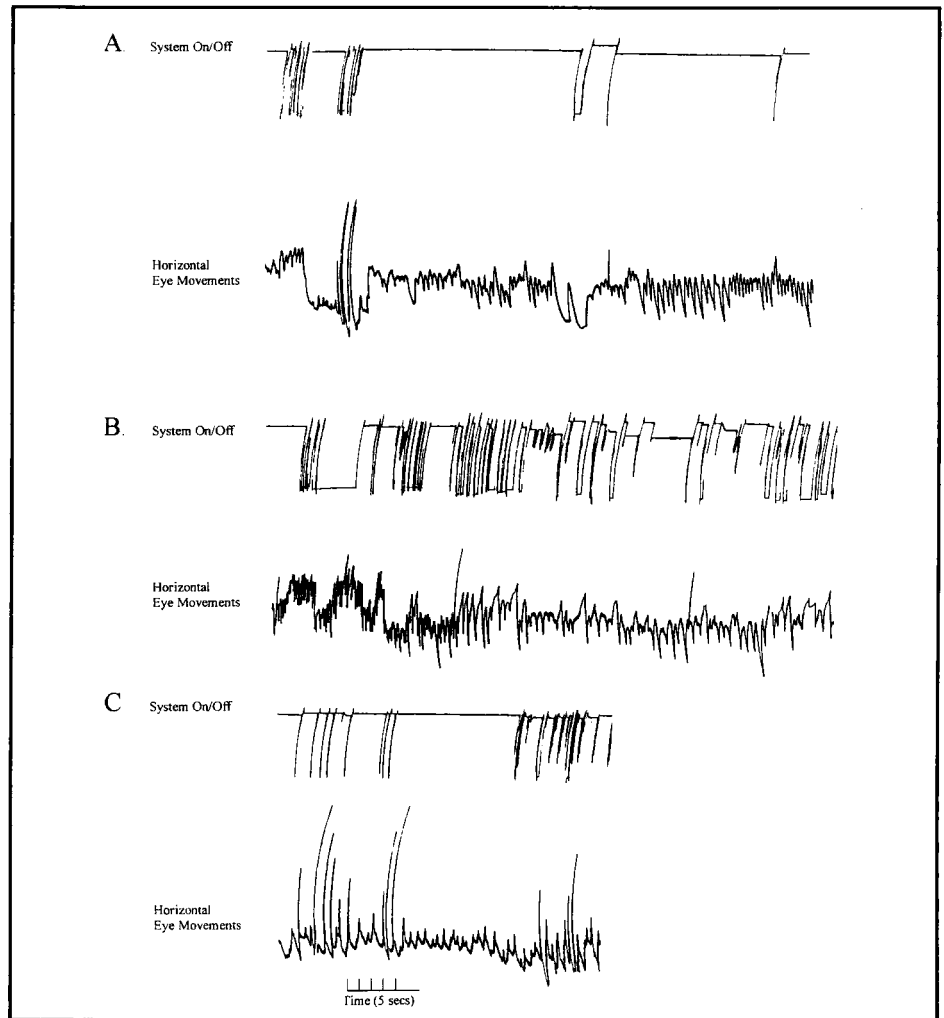

Figure 8. Eye movements and system responses in a 7-year-old congenital nystagmat. Large deflections are blinks. Session 1. (A) At beginning of session; calibration of $\pm 3.5^\circ$ followed by midline fixation; $\pm 3.5^\circ$ deadband. (B) Later in session; $\pm 1.75^\circ$ deadband. (C) At end of session; $\pm 1.75^\circ$ deadband.

importance than in adults (e.g., amblyopia and nystagmus). If even relatively briefly one can reduce the abnormality of her eye movements and thereby increase the percent time of normal retinal-imaging, one may reduce, prevent, or even reverse the adverse effects on the visual system re-

sulting from the child's earlier abnormal visual experiences, i.e., smearing of the retinal image due to increased retinal-image motion.^{9,12}

There are three reports dealing with oculomotor auditory feedback that included young children in the 5-10 year age

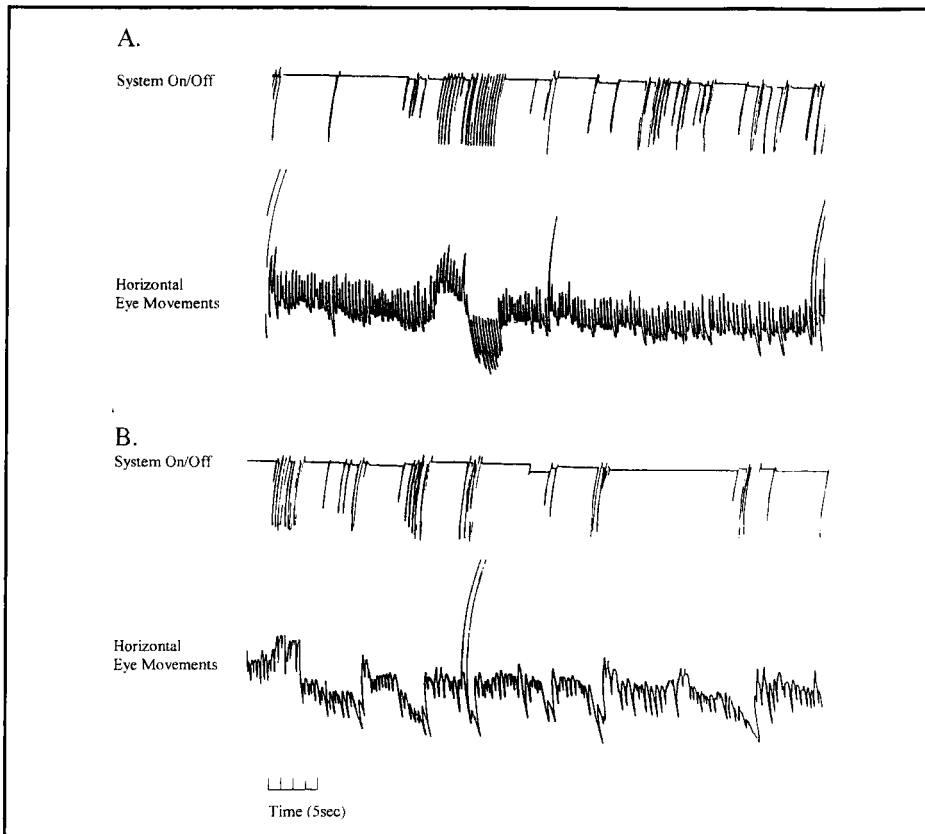

Figure 9. Eye movements and system responses in a 7-year-old congenital nystagmat. Session 2. (A) Midline fixation, calibration, and midline fixation again; $\pm 3.5^\circ$ deadband. (B) Later in session; calibration followed by midline fixation; $\pm 1.75^\circ$ deadband.

range. In a study of 10 nystagmats ranging in age from 8-16 years, auditory feedback oculomotor rehabilitation was implemented in conjunction with simple visual feedback consisting of a large analog meter whose pointer varied with nystagmus amplitude and intensity.¹⁰ The results demonstrated a considerable decrease in nystagmus and a modest correlated improvement in both Snellen visual acuity and contrast sensitivity in many of the children. This study lends support to our decision to use alternate and combined forms of feedback therapy with young children in hopes of developing eye movement awareness and subsequent control. Sharma et al¹¹ used auditory feedback alone in 10 nystagmats ranging in age from 4-28 years, including a 4-year-old and an 8-year-old. All were found to attain approximately a 50-60% reduction of their nystagmus, but only during the actual test sessions; the habitual level of nystagmus returned once the tone was removed. Furthermore, there was little improvement in either visual acuity or contrast sensitivity. However, their modest findings may be attributed to the relatively short total training period (3

hours over a 3-week period) as well as the young ages of the subjects. And, we reported motor improvement in a few children between the ages of 8-10 years who only received auditory feedback in our preliminary investigation. These children exhibited excellent behavior and a relatively long attention span for their age. However, the younger children (i.e., 4-7 years of age) could not understand the task.⁹

In conventional oculomotor auditory feedback used in the training of adults with nystagmus,^{5,12} the patient hears a tone that is correlated with changes in horizontal eye position. He/she is then asked to reduce the jerkiness of the tone using some unspecified internal control strategy or trigger mechanism via a trial-and-error approach. However, a young nystagmat, e.g., a 5-year-old, is usually not very aware that his/her eyes are moving abnormally or of the related visual consequences. Furthermore, the cosmetic aspects of the abnormal eye movements are of little interest to someone of that age. In essence, the child does not perceive a problem; the parents do.

A two-fold question then arises: Can a child as young as 5 years of age conceptualize that this auditory tone is representative of his abnormal eye movements, and secondly, can he develop via trial-and-error the internal control strategy or trigger mechanism which would result in the requisite auditory-to-oculomotor transformation? We decided that visual rather than the more conventional auditory oculomotor feedback would be more effective in maintaining a young child's attention, as well as attaining an understanding and overall conceptualization of the process during the training session. Children are known for their unwavering attention while watching television programs that interest them. So, if the television image becomes extinguished, as was done in the present experiment when oculomotor performance decreased, we assumed they would be highly motivated to restore the video image. This was clearly the case.

Although the ultimate goal was to develop a visual feedback system that could be used to train very young children to control their eye movements, especially those with nystagmus, it was determined that the primary experiment needed to be preceded by a number of steps. Thus, there were two sets of control subjects tested in addition to the visually-normal children. The first included two visually-normal, young adult optometry students. They were tested to determine if this prototype system (patent pending) was able to track and relay eye movement information rapidly and reliably to a strip chart recorder for hard copy and to control simultaneously the video stimulus electronically. The second control consisted of the adult subject with nystagmus. She was studied to determine if the prototype system was able to monitor and relay the abnormal, high frequency nystagmoid eye movements reliably to the strip chart recorder for hard copy, as well as to control the deadband and video stimulus appropriately. Furthermore, this experienced subject was valuable to assess how readily the combined visual and auditory information could be processed and, if indeed the auditory feedback was beneficial when used in conjunction with the primary visual feedback.

All of the control subjects were able to comprehend and comply with the instructions set forth by the experimenters quite

readily. One of the most important findings was that our visually-normal children, as young as 5 years of age, were able to understand and easily follow the directions within a few minutes. They exhibited little difficulty in controlling their ability to fixate reasonably steadily, or to make multiple saccadic eye movements upon command to accomplish the intended goals, i.e., “turn on or turn off the video with your eyes.”

When the visually-normal adult was introduced to the combined auditory and visual feedback, he reported that in contrast to the situation with visual feedback alone, the combined feedback did not add much to improve his ability to maintain steady fixation. Thus, the auditory feedback did not provide the subject with much if any additional information in enhancing his ability to attend sensorimotor-wise to the stimulus, presumably because the patient was already accurately fixating within his own internal criterion level. This was also the case for the visually-normal child who was provided the combined feedback. The visually-normal child stated that it made no difference whether or not the tone was on, as he could accomplish the fixation task with the same apparent ease in both cases. These results were somewhat similar to those of Smith,¹³ where visually-normal individuals found that the additional feedback was not helpful.

This was also the case when the adult with nystagmus was provided with the combined feedback. This experienced subject reported that the added tone was distracting, as Smith¹³ found in his visually-normal individuals. However, and most interestingly, the subject also reported that she had to try hard to keep the tone constant in order to hear the storyteller better. The tone, in essence, forced her to maintain steady fixation despite the sense of distraction. We have also found this to be the case in some visually-normal subjects during their training of reading eye movements.¹⁴

We then used the visual feedback paradigm with the 7-year-old nystagmat. Like his visually-normal peers, the child had no difficulty comprehending and following the instructions. Upon interviewing the subject, he claimed that he was indeed aware that his eyes “jiggled,” but that this did not trouble him in any way. During the training sessions, he was able to reduce his

nystagmus in both frequency and amplitude. After three additional 30-minute sessions over a one month period, the child’s mother expressed that at times she noted a marked reduction in her son’s frequency of nystagmus. At that session, he was then introduced to the auditory feedback component. This very bright child understood and even repeated to the experimenters how the tone was representative of his nystagmoid eye movements. Nevertheless, while he appeared to conceptualize that the auditory tone was representative of his abnormal eye movements, he could not develop and rapidly learn the requisite internal control mechanism which would result in the required auditory-to-oculomotor transformation to obtain eye stability, at least during the one session in which this was attempted. Obviously, there is the need for a long-term study using a large group of children with nystagmus between the ages of 3 to 10 years to evaluate the effect of visual feedback training on reduction of the frequency and amplitude of the nystagmus, as well as on the improvement of other vision functions such as visual acuity and contrast sensitivity.

In addition, this device should be evaluated for fixational and saccadic training in other ocular conditions such as amblyopia, strabismus, neurological disorders and acquired brain injury, in which eye movement abnormalities are prevalent (Table 2). Moreover, this apparatus has application in the training of visually-normal individuals, both children and adults, who manifest reading difficulty of primary oculomotor origin.⁴ Lastly, it may also have application in the training of normal adults with exceptional visual demands to enhance and optimize fixational and saccadic ability such as fighter pilots, astronauts, military gunners, race car drivers, sportsmen, etc., where even a small

Table 2

Therapeutic Uses of Oculomotor Feedback

- To improve fixation in nystagmus (congenital and acquired)
- To improve fixation, reading eye movements, and visual scanning strategies in acquired brain injury (traumatic brain injury and stroke)
- To change from eccentric to centric (i.e., foveal) fixation in amblyopic eyes
- To embed and stabilize fixational eccentric viewing in central scotomas (e.g., macular degeneration)
- To improve reading and visual scanning ability in central scotomas and hemianopias
- To attain bifixation in strabismus
- To improve inefficient oculomotor skills of a functional origin in children
- To increase reading eye movement efficiency in normal and slow readers having a primary oculomotor etiology
- To improve reading eye movement ability in pathological oculomotor dysfunctions (e.g., nystagmus, abnormal saccadic intrusions, muscle paresis)

enhancement may have substantial and perhaps even life-saving consequences.

The question remains as to what is being trained. Are we training eye movements, attention, relaxation, or all three? What are the underlying neural mechanisms and correlated anatomical substrates evoked by such feedback that stimulates higher level cognitive processes to initiate voluntary control of previously unconscious processes? Many adult patients with nystagmus that have been successful with auditory feedback training have expressed that one of the strategies to initially reduce their nystagmus was relaxation.⁹ Moreover, when one instructs a nystagmat to concentrate and attempt very hard to reduce the nystagmus, this instructional set will actually increase their nystagmoid movement in a “positive feedback” manner. However, if you instruct the patient to gaze and relax, there eventually is a reduction in both amplitude and frequency of the nystagmus, i.e., an effective dampening of the nystagmus.^{4,5,12}

Two studies using PET brain-imaging techniques have provided insights into this important question. Critchley et al¹⁵ investigated cerebral activity related to relaxation. He found that relaxation without biofeedback was associated with increased activity in the left anterior cingulate gyrus and globus pallidus. When subjects combined relaxation with biofeedback, there was an enhanced response in the left anterior cingulate and, in

addition, cerebellar vermal activity. Lazar et al¹⁶ evaluated relaxation secondary to meditation and found that there was significant increase in the putamen, midbrain, pregenual anterior cingulate cortex, hippocampal and parahippocampal activity. Hence, neural correlates to relaxed states were evident.

Perhaps in our young subjects the visual feedback, in conjunction with the act of listening to a story, triggered increased relaxation affecting some of the above brain centers as well as attention centers, which in turn decreased the nystagmus. This would also explain the dynamic change in nystagmus waveform observed during the actual training process.

Future investigations should be directed at evaluating visual and/or auditory feedback therapy concurrent with brain imaging (e.g., PET) to ascertain which regions of the brain are activated during this specialized training process, in children as well as in adults manifesting oculomotor disorders.

Acknowledgement

We thank John Orzuchowski for building the electronic circuitry, and interfacing it to the eye movement system and video stimulus display.

References

1. Spilker B. Special modalities: feedback, radiation therapy, hyperthermia, hypnosis, electroconvulsive therapy, apheresis, and hyperbaric oxygen. In: Spilker B, ed. *Guide to Clinical Trials*. New York: Raven Press, 1991.
2. Halperin E, Yolton RL. Ophthalmic applications of feedback. *Am J Optom Physiol Optics* 1986;63:985-998.
3. Fuller G. Current status of feedback in clinical practice. *Am Psychol* 1978;33:39-48.
4. Ciuffreda KJ, Tannen B. Training of nystagmus: a multi-sensory approach. *J Behav Optom* 1999;10:1-4.
5. Ciuffreda KJ, Tannen B, Rutner D. Multi-sensory feedback therapy for oculomotor dysfunction. In: Hung GK, Ciuffreda KJ, eds. *Models of the Visual System*. New York: Kluwer/Plenum, 2002:741-769.
6. Groffman S. Operant conditioning and vision training. *Am J Optom Arch Am Acad Optom* 1968;46:583-594.
7. Feldman J. Behavior modification in vision training: facilitating prerequisite behaviors and skills. *J Am Optom Assoc* 1981;52:329-340.
8. Leigh RJ, Zee DS. *The neurology of eye movements*. New York: Oxford, 3rd ed., 1999.
9. Ciuffreda KJ, Tannen B. *Eye movement basics for the clinician*. St. Louis: Mosby Yearbook, 1995.
10. Alvaro RA, Varela PA, Fernandez-Abascal GE, Plaza SC, Garcia CL. Rehabilitacion oculomotora mediante biorretalimention: un programa de aplicacion al nistagmus, Integracion, October 28, 1998:5-15.

11. Sharma P, Tandon R, Kumar S, Anand S. Reduction of congenital nystagmus amplitude with auditory biofeedback. *J Am Assoc Ped Ophthal Strab* 2000; 4:287-290.
12. Ciuffreda KJ, Goldrich S. Oculomotor feedback therapy. *Internat Rehabil Med* 1983;5:111-117.
13. Smith WM. Control of eye fixation by auditory feedback. *Psychon Sci* 1964;1:233-234.
14. Fayos B, Ciuffreda KJ. Oculomotor auditory biofeedback training to improve reading efficiency. *J Behav Optom* 1998; 9:143-152.
15. Critchley HD, Mermed RN, Featherstone E, Mathias CJ, Dolan RJ. Brain activity during feedback relaxation: a functional neuro-imaging investigation. *Brain* 2001; 124:1003-1012.
16. Lazar W, Bush G, Gollub RL, Fricchione GL, Khalsa G, Benson H. Functional brain mapping of the relaxation response and meditation, *Neuro Report* 2001; 2:1581-1585.

Corresponding author:

Kenneth J. Ciuffreda, O.D., Ph.D.
Department of Vision Sciences
SUNY/State College of Optometry
33 West 42nd Street
New York, NY 10036

Date accepted for publication:
June 10, 2002